

Proiectant General: B. I. A. EMIL A. CRIȘAN

verificator expert	ing. Bodor Csaba	<i>[Signature]</i>	A1	24 / 07. 10. 2016
verificator / expert	nume	semnatura	cerinta	referat / expertiza nr. / data <b>000982</b>

<b>LINEA S.R.L. SF. GHEORGHE</b> str. Gróf Mikó Imre nr. 4, bl. 1/ E / 24 Reg. Com. J 14 /122 /1999 C.U.I. RO 11942771 tel./fax 0267-315714, web: www.linea-proiect.ro	Denumirea:	REABILITAREA ANSAMBLULUI BISERICII EVANGHELICE FORTIFICATE AGNITA	proiect. nr.	180 / 2018
	Localitatea:	AGNITA, Piata G.D. Teutsch, nr. 1-3, jud. SIBIU	faza:	P. T. + D. E.
	Beneficiar:	Parohia Evanghelică C.A. Agnita		

sef. proiect proiectat	arh. Emil Crișan ing. Bodor Csaba	<i>[Signature]</i>	scara:	titlul plansei:	TURNURI PLAN DE SITUATIE	nr. pl.	R - 201
desenat	Balázs Márta	<i>[Signature]</i>	1:500				
data elaborarii proiectului:		2018					

toate drepturile rezervate. Este interzisă reproducerea sau utilizarea în orice formă a conținutului acestui proiect fără aprobarea scrisă a proiectantului. Este interzisă pe orice fel de mijloc de comunicare în publică reproducerea sau utilizarea în orice formă a conținutului acestui proiect fără aprobarea scrisă a proiectantului.



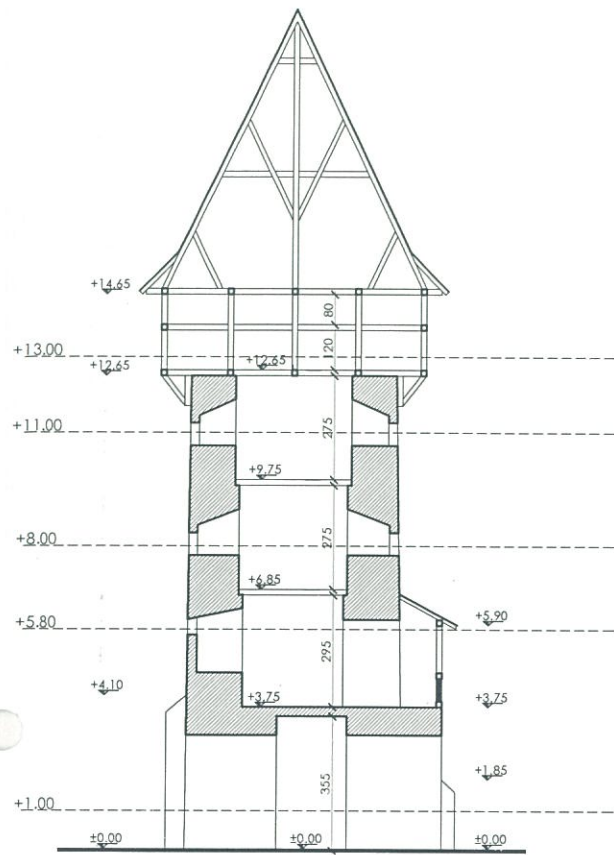

SECTIUNE TRANSVERSALA

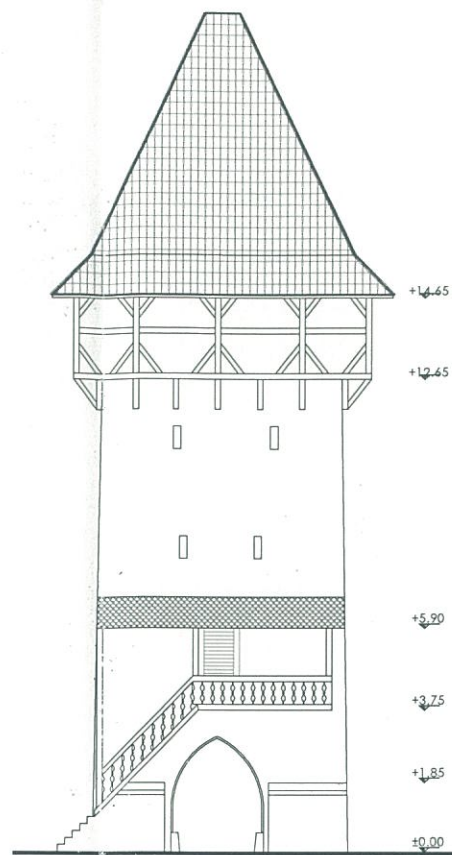

FATADA SUD

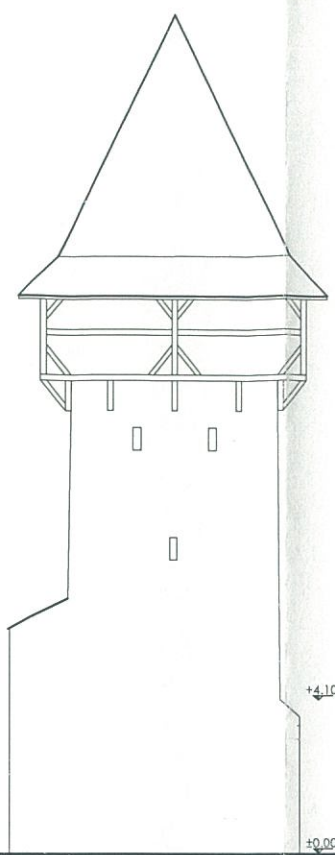

FATADA EST

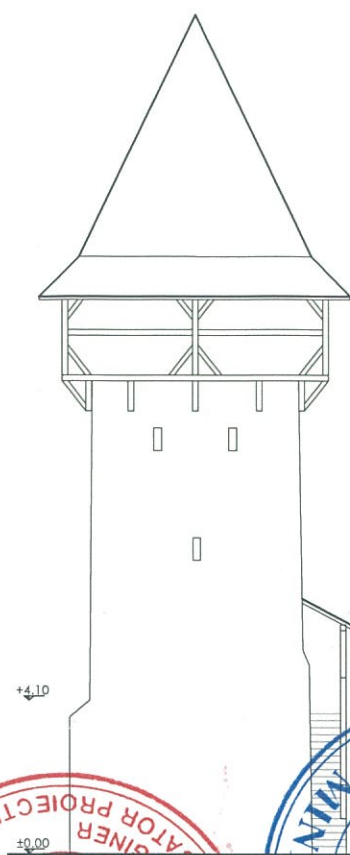

FATADA VEST

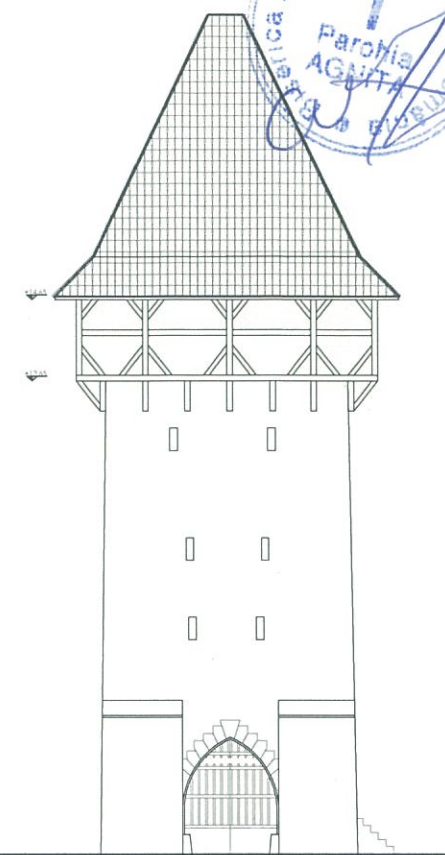

FATADA NORD

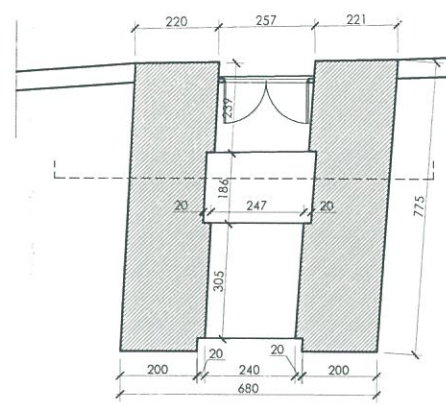

PLAN COTA +1.00 m

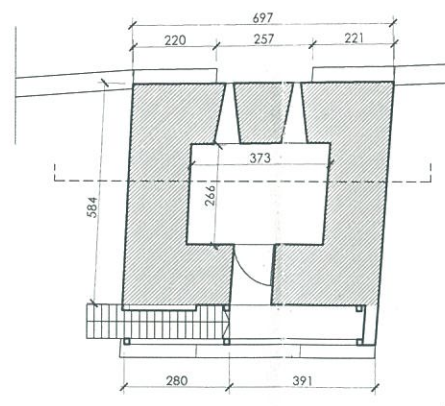

PLAN COTA +5.80 m

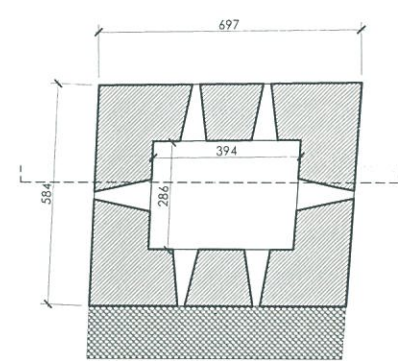

PLAN COTA +8.00 m

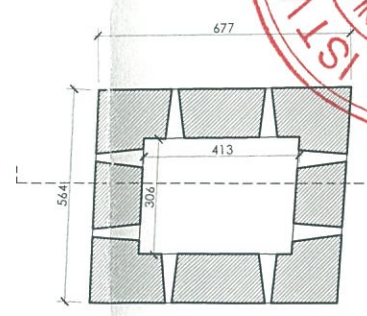

PLAN COTA +11.00 m

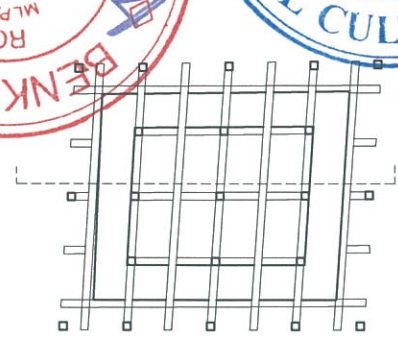

PLAN COTA +13.00 m

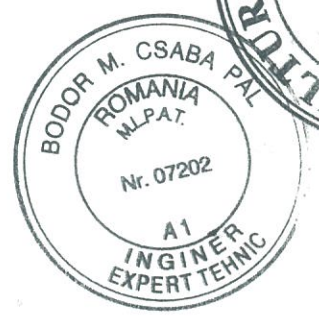

Proiectant General: B. I. A. EMIL A. CRISAN

verificator				
expert	ing. Bodor Csaba			24 / 07. 10. 2016
verificator / expert	nume	semnatura	cerinta	referat / expertiza nr. / data

<b>LINEA S.R.L. SF. GHEORGHE</b> str. Gróf Mikó Imre nr. 4, bl. 1/ E / 24 Reg. Com. J 14 / 122 / 1999 C.U.I. RO 11942771 tel./fax 0267-315714, web: www.linea-proiect.ro		Denumirea: REABILITAREA ANSAMBLULUI BISERICII EVANGHELICE FORTIFICATE AGNITA Localitatea: AGNITA, Piata G.D. Teutsch, nr. 1-3, jud. SIBIU Beneficiar: Parohia Evanghelică C.A. Agnita	proiect. nr. 180 / 2018 faza: P. T. + D. E.
sef. proiect arh. Emil Crisan proiectat ing. Bodor Csaba desenat Balázs Márta data elaborării proiectului: 2018	scara: 1:200 titlul plansei: TURNUL DOGARILOR/DULGHERILOR releveu	nr. pl. R - 203	

acest proiect este proprietatea S.C. LINEA SRL și asupra sa funcționează legea copyright-ului. El nu poate fi folosit în ansamblu sau în părți ale sale decât cu aprobarea scrisă a S.C. LINEA SRL. Orice modificare ulterioară a proiectului, fără aprobarea scrisă a proiectantului, îl absolvează pe acesta de orice răspundere.

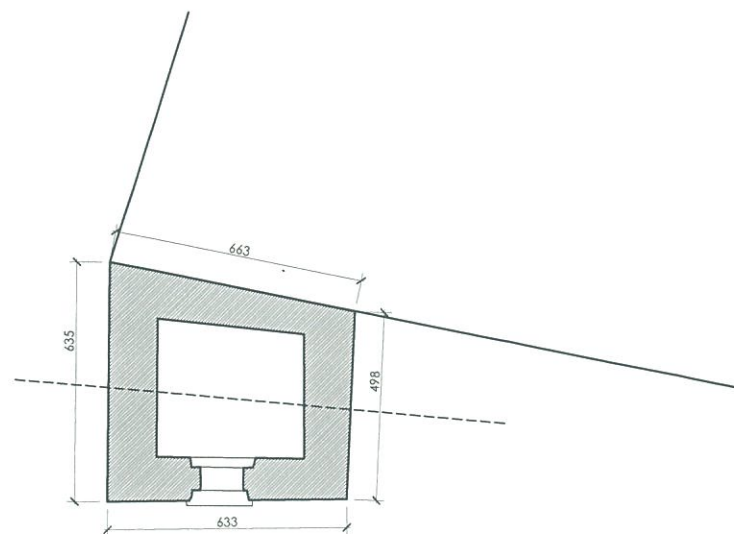
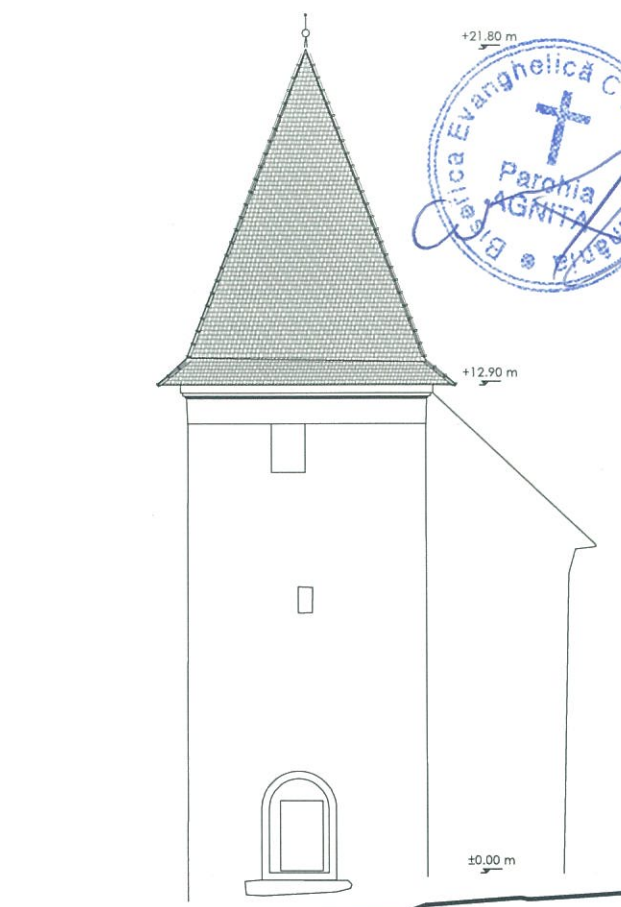
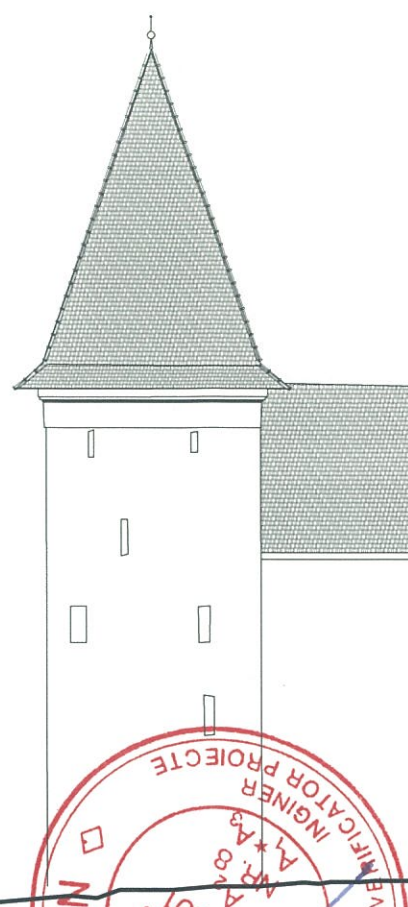
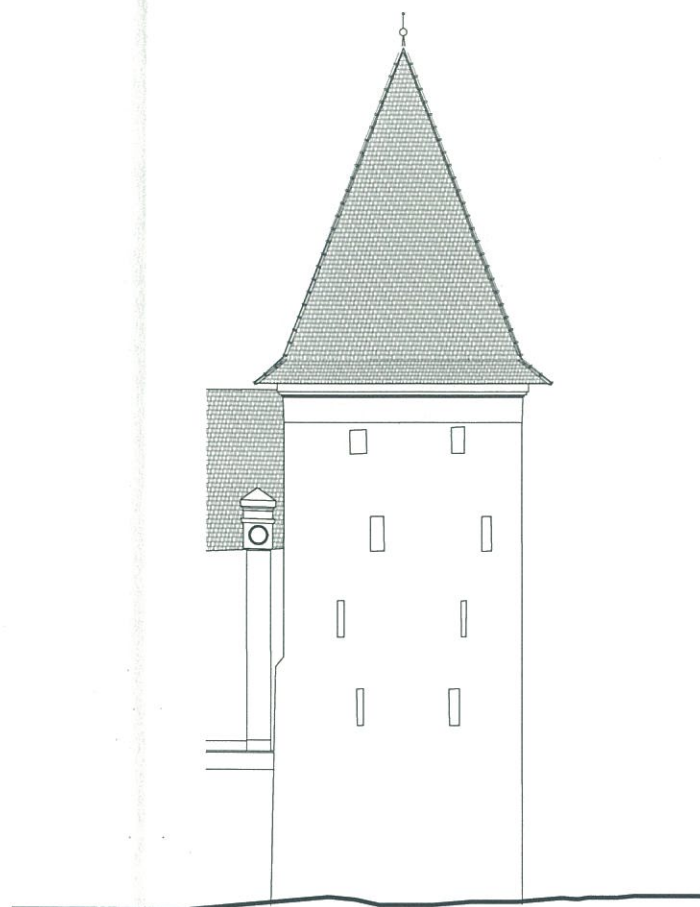
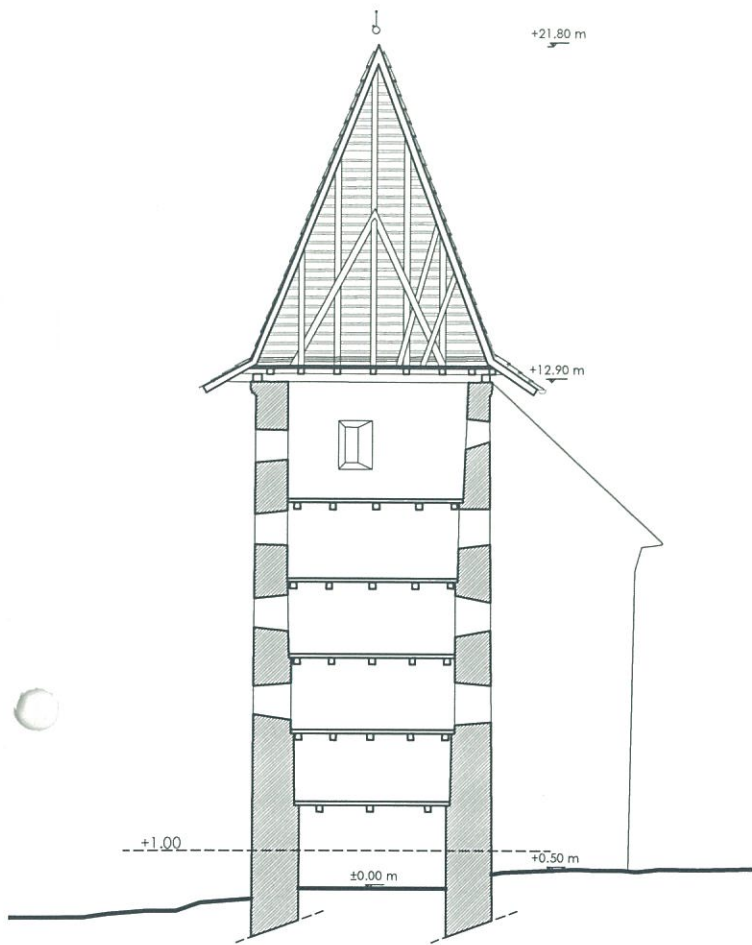

PLAN COTA +1.00m

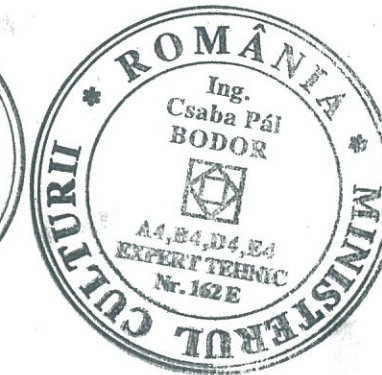

Proiectant General: B. I. A. EMIL A. CRIȘAN

verificator				
expert	ing. Bodor Csaba		A1	24 / 07. 10. 2016
verificator / expert	nume	semnatura	cerinta	referat / expertiza nr. / data

<b>LINEA S.R.L. SF. GHEORGHE</b> str. Gróf Mikó Imre nr. 4, bl. 1/ E / 24 Reg. Com. J 14 /122 /1999 C.U.I. RO 11942771 tel./fax 0267-315714, web: www.linea-proiect.ro		Denumirea:	REABILITAREA ANSAMBLULUI BISERICII EVANGHELICE FORTIFICATE AGNITA	proiect. nr.	180 / 2018
		Localitatea:	AGNITA, Piata G.D. Teutsch, nr. 1-3, jud. SIBIU	faza:	P. T. + D. E.
		Beneficiar:	Parohia Evanghelică C.A. Agnita		
sef. proiect	arh. Emil Crișan	scara:	titlul plansei:	nr. pl.	
proiectat	ing. Bodor Csaba	1: 200	TURNUL FIERARILOR releveu	R - 204	
desenat	Balázs Márta				
data elaborarii proiectului:		2018			

acest proiect este proprietatea SC LINEA SRL si asupra sa functioneaza legea copyrightului. El nu poate fi total sau in parte dat sau de alt cu aprobarea scrisa a SC LINEA SRL. Orice modificare ulterioara a proiectului, facuta fara aprobarea scrisa a proiectantului, este facuta pe account de orice raspundere.

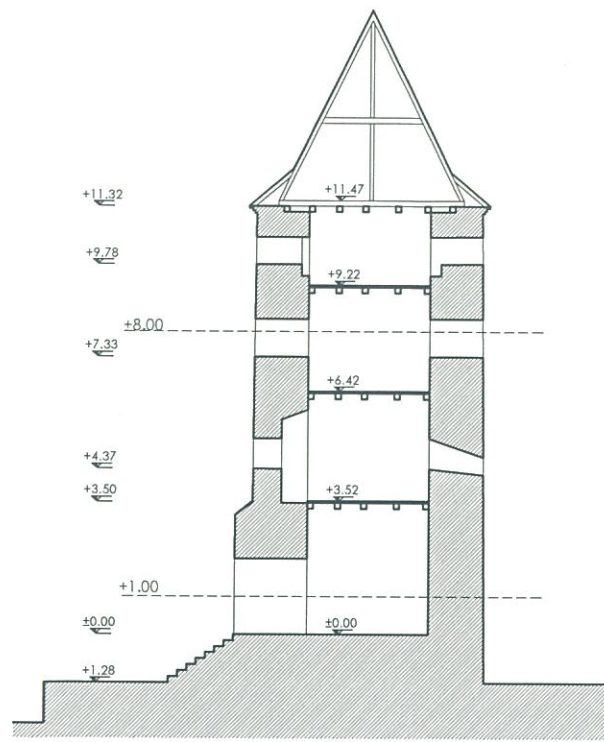

SECTIUNE

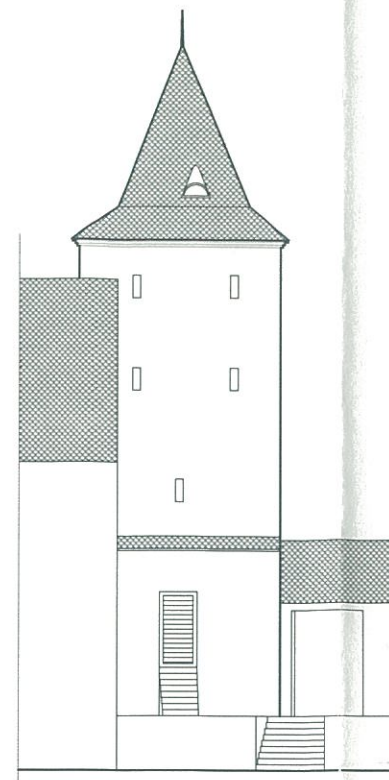

FATADA  
NORD

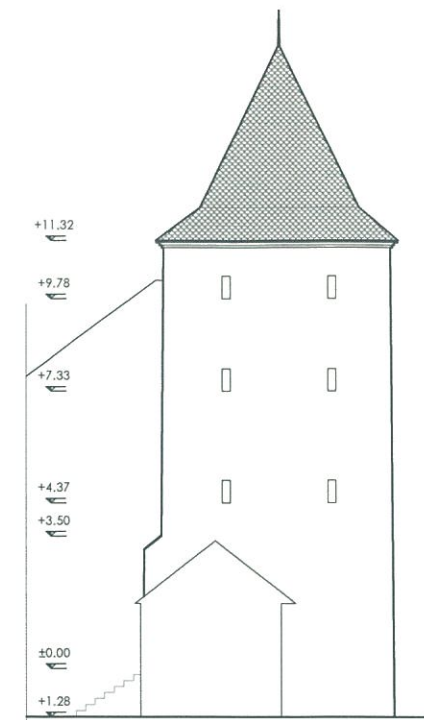

FATADA  
VEST

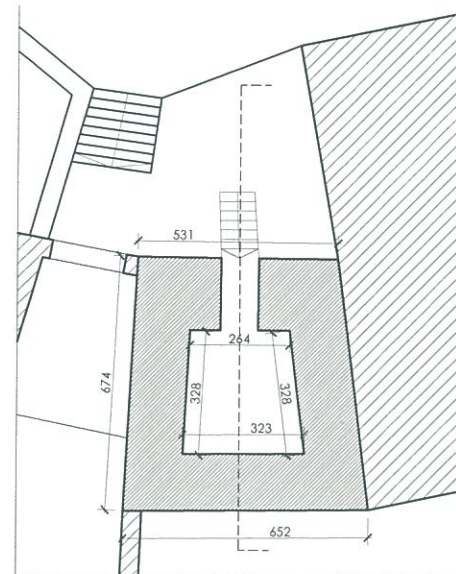

PLAN COTA  
+1.00m

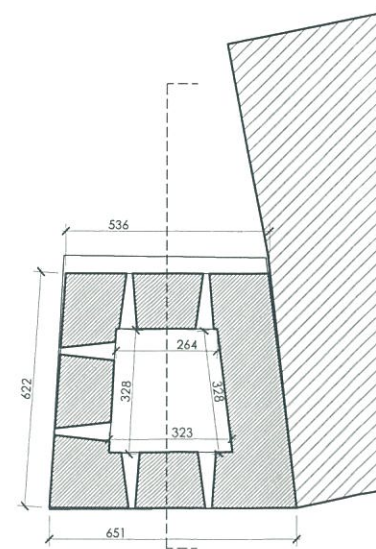

PLAN COTA  
+8.00m



Proiectant General: B. I. A. EMIL A. CRIȘAN

verificator	ing. Bodor Csaba		AI	24 / 07. 10. 2016	000986
expert					
verificator / expert	nume	semnatura	cerinta	referat / expertiza nr. / data	

<b>LINEA S.R.L. SF. GHEORGHE</b> str. Gróf Mikó Imre nr. 4, bl. 1/ E / 24 Reg. Com. J 14 / 122 / 1999 C.U.I. RO 11942771 tel./fax 0267-315714, web: www.linea-proiect.ro		Denumirea:	REABILITAREA ANSAMBLULUI BISERICII EVANGHELICE FORTIFICATE AGNITA	proiect. nr.	180 / 2018
sef. proiect arh. Emil Crișan proiectat ing. Bodor Csaba desenat Balázs Márta data elaborării proiectului: 2018		Localitatea:	AGNITA, Piata G.D. Teutsch, nr. 1-3, jud. SIBIU	faza:	P. T. + D. E.
		Beneficiar:	Parohia Evanghelică C.A. Agnita	nr. pl.	R - 205
		scara:	1: 200	titlul plansei:	TURNUL CROITORILOR releveu

© 2018 proiect este proprietatea SC LINEA SRL si asupra sa functioneaza legea copyrightului. Este poata fi folosit in ansamblu sau in parti ale sale decat cu aprobarea scrisa a SC LINEA SRL. Orice modificare ulterioara a proiectului, inclusiv fara aprobarea scrisa a proiectantului, este o abuz pe acesta de orice raspundere.