

LEGENDA:

- fantă de aerisire perimetrală
- hidroizolație PLĂCI TEFOND
- trotuar din lespezi de piatră în pat de nisip

Proiectant General: B. I. A. EMIL A. CRISAN

verificator	ing. Bodor Csaba	A1	24 / 07. 10. 2016
expert	nume	semnatura	referat / expertiza nr. / data

<b>LINEA S.R.L. SF. GHEORGHE</b> str. Gróf Mikó Imre nr. 4, bl. 1/ E / 24 Reg. Com. J 14 / 122 / 1999 C.U.I. RO 11942771 tel./fax 0267-315714, web: www.linea-proiect.ro		Denumirea: REABILITAREA ANSAMBLULUI BISERICII EVANGHELICE FORTIFICATE AGNITA Localitatea: AGNITA, Piata G.D. Teutsch, nr. 1-3, jud. SIBIU Beneficiar: Parohia Evanghelică C.A. Agnita	proiect. nr. 180 / 2018 faza: P. T. + D. E.
sef. proiect arh. Emil Crisan proiectat ing. Bodor Csaba desenat Balázs Márta data elaborării proiectului: 2018	scara: 1: 150 titlul plansei: Biserica PLAN PARTER - reabilitare fundații	nr. pl. R - 101	

toate proiectele sunt proprietatea SC LINEA SRL si asupra sa functioneaza toate copyright-urile. El nu poate fi folosit in ansamblu sau in parti de sine decat cu aprobarea scrisa a SC LINEA SRL. Orice modificare ulterioara a proiectului, fara aprobarea scrisa a proiectantului, este facuta pe aceasta de catre raspundator.

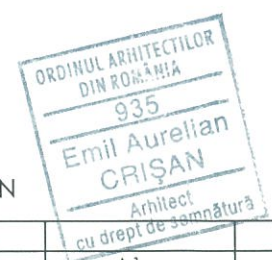
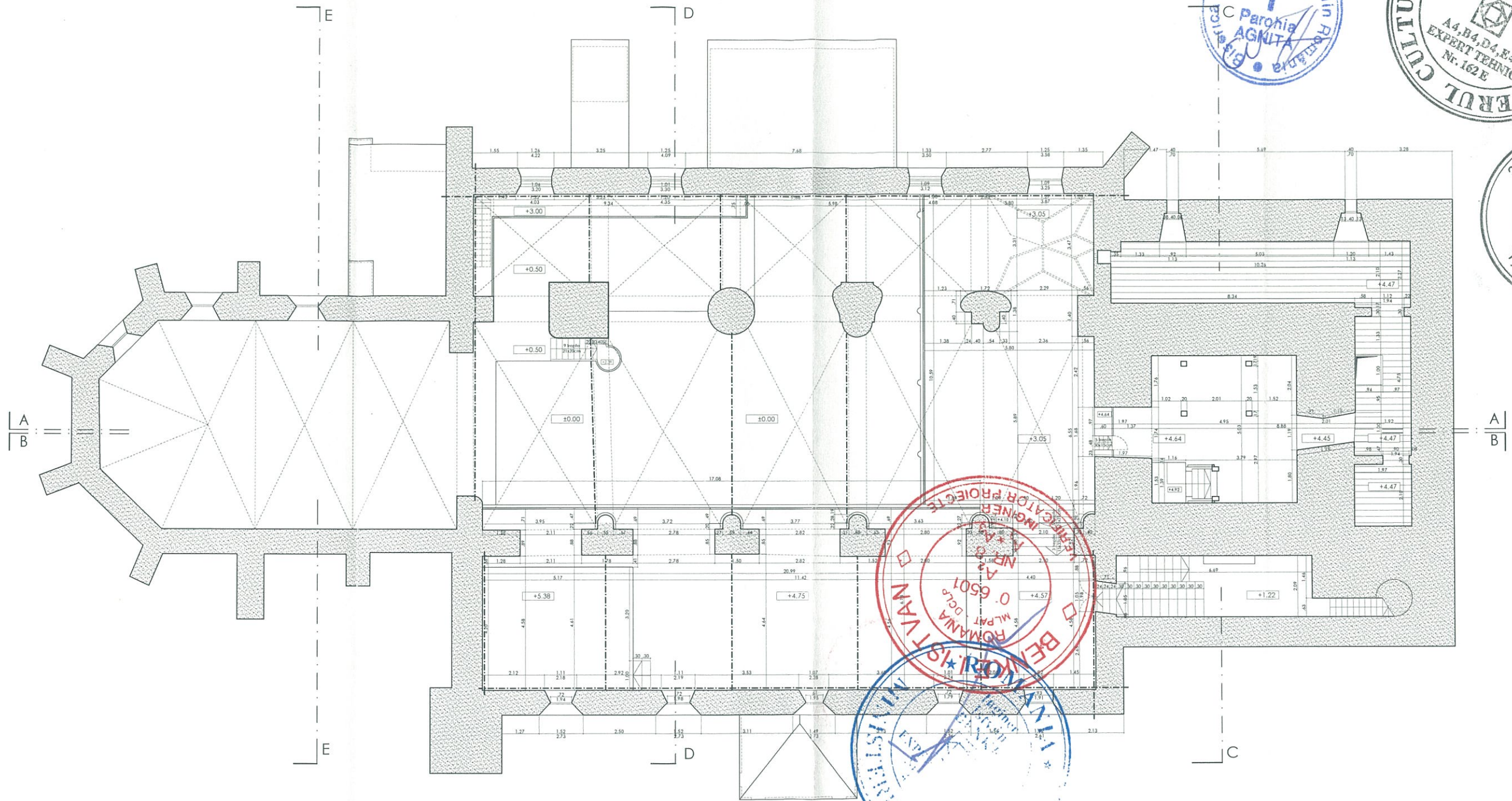

LEGENDA:

----- tiranți metalici existenți

Proiectant General: B. I. A. EMIL A. CRIȘAN

verificator	ing. Bodor Csaba		A1	24 / 07. 10. 2016
expert				
verificator / expert	nume	semnatura	cerinta	referat / expertiza nr. / data 000972

<b>LINEA S.R.L. SF. GHEORGHE</b> str. Gróf Mikó Imre nr. 4, bl. 1/ E / 24 Reg. Com. J 14 / 122 / 1999 C.U.I. RO 1194277 tel./fax 0267-315714, web: www.linea-proiect.ro		Denumirea: REABILITAREA ANSAMBLULUI BISERICII EVANGHELICE FORTIFICATE AGNITA Localitatea: AGNITA, Piata G.D. Teutsch, nr. 1-3, jud. SIBIU Beneficiar: Parohia Evanghelică C.A. Agnita	proiect. nr. 180 / 2018 faza: P. T. + D. E. nr. pl. R - 102
sef. proiect arh. Emil Crișan proiectat ing. Bodor Csaba desenat Balázs Márta data elaborarii proiectului: 2018	scara: 1: 150 titlul plansei: BISERICA PLAN LA COTA: + 5.00		

Acest proiect este proprietatea SC LINEA SRL și asupra sa funcționează legea copyrightului. El nu poate fi folosit în ansamblu sau în părți ale sale decât cu aprobarea scrisă a SC LINEA SRL. Orice modificare ulterioară a proiectului, fără aprobarea scrisă a proiectanților, este făcută pe propria răspundere.

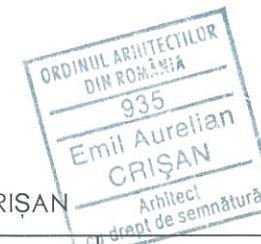
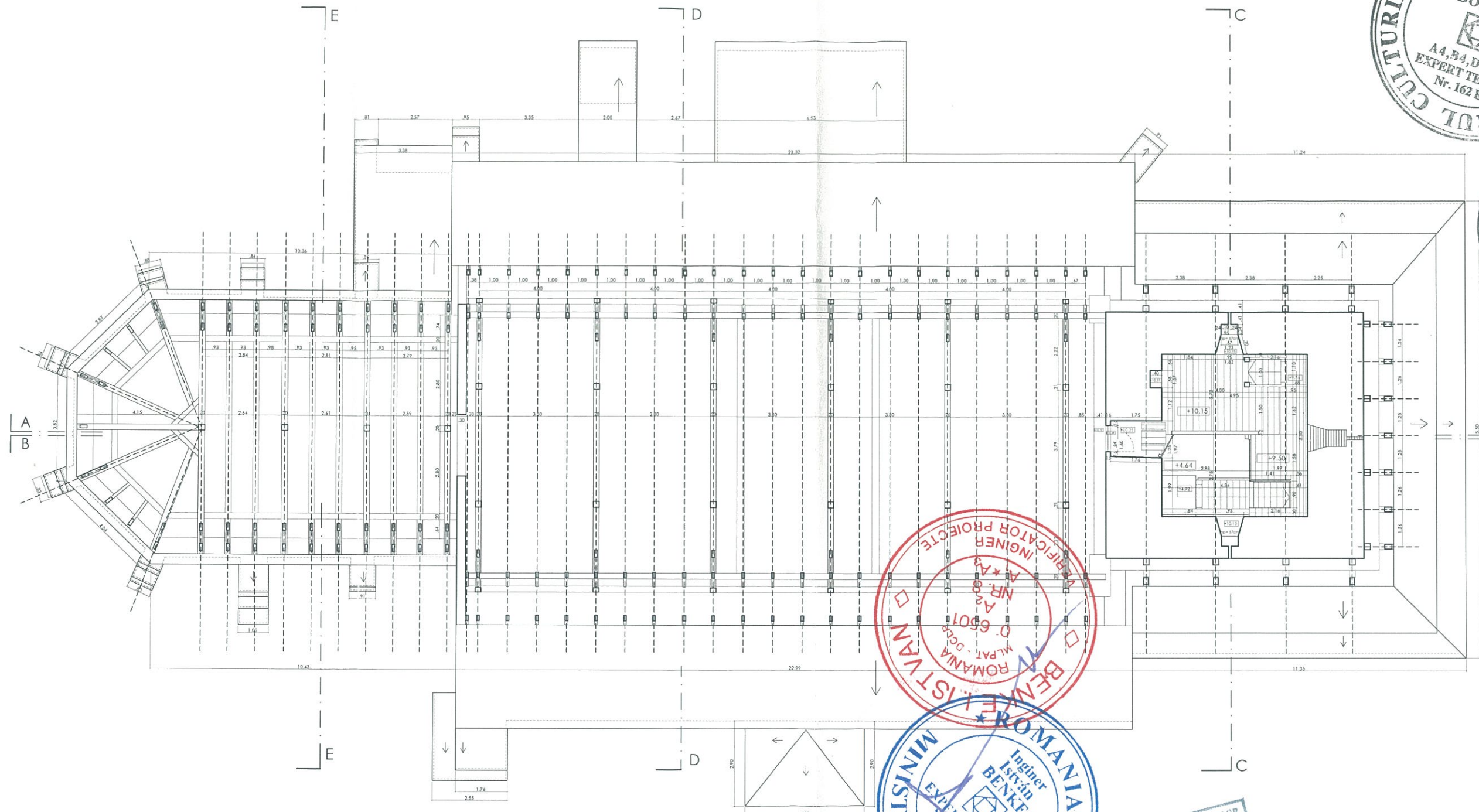

Proiectant General: B. I. A. EMIL A. CRIȘAN

verificator	ing. Bodor Csaba	8	A1	24 / 07. 10. 2016
expert	nume	semnatura	cerinta	referat / expertiza nr. / data
verificator / expert				000975
<b>LINEA S.R.L. SF. GHEORGHE</b> str. Gróf Mikó Imre nr. 4, bl. 1/ E / 24 Reg. Com. J 14 / 122 / 1999 C.U.I. RO 11942771 tel./fax 0267-315714, web: www.linea-proiect.ro			Denumirea:	REABILITAREA ANSAMBLULUI BISERICII EVANGHELICE FORTIFICATE AGNITA
			Localitatea:	AGNITA, Piata G.D. Teutsch, nr. 1-3, jud. SIBIU
			Beneficiar:	Parohia Evanghelică C.A. Agnita
sef. proiect	arh. Emil Crișan	8	scara:	titlul plansei:
proiectat	ing. Bodor Csaba	8	1: 150	BISERICA
desenat	Balázs Márta	74		PLAN LA COTA: +11.50
data elaborarii proiectului:	2018			nr. pl. R - 103

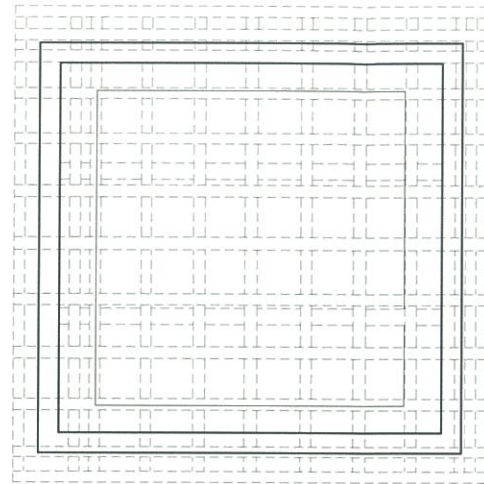

PLAN GRINZI  
NIVEL  
CLOPOTNIȚĂ

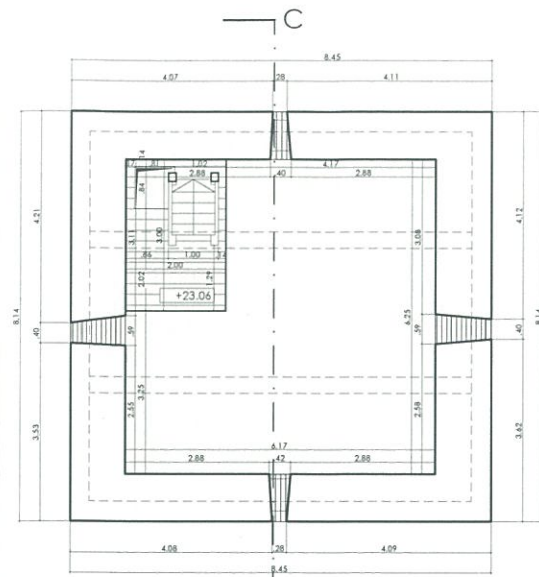

PLAN COTA  
+24.90m

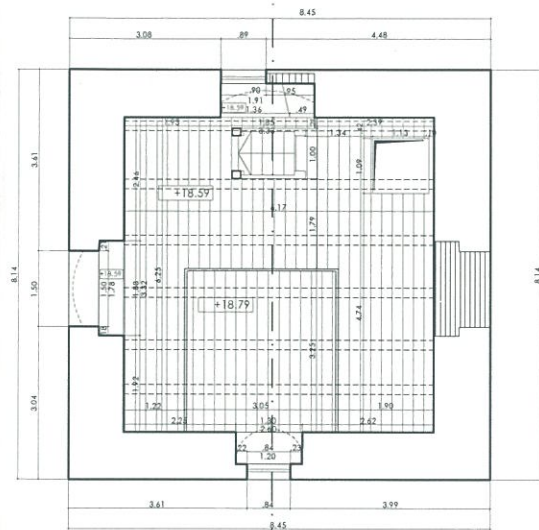

PLAN COTA  
+20.50m

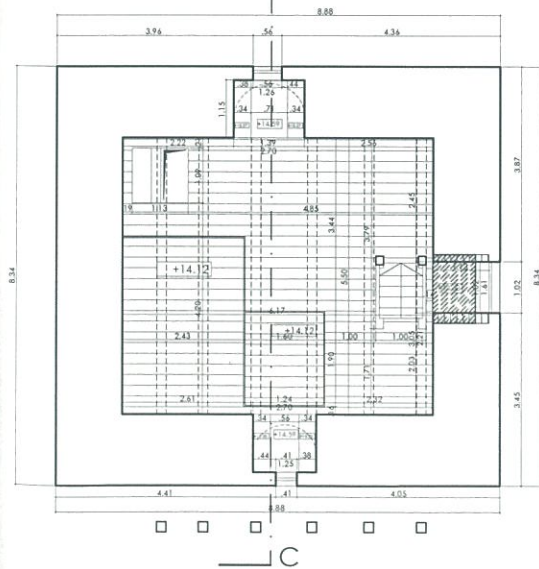

PLAN COTA  
+15.80m



Proiectant General: B. I. A. EMIL A. CRIȘAN

verificator	ing. Bodor Csaba	<i>[Signature]</i>	A1	24 / 07. 10. 2016
expert				
verificator / expert	nume	semnatura	cerinta	referat / expertiza nr. / data 000974
LINEA S.R.L. SF. GHEORGHE str. Gróf Mikó Imre nr. 4, bl. 1/ E / 24 Reg. Com. J 14 / 122 / 1999 C.U.I. RO 11942771 tel./fax 0267-315714, web: www.linea-proiect.ro			Denumirea:	REABILITAREA ANSAMBLULUI BISERICII EVANGHELICE FORTIFICATE AGNITA
			Localitatea:	AGNITA, Piata G.D. Teutsch, nr. 1-3, jud. SIBIU
			Beneficiar:	Parohia Evanghelică C.A. Agnita
sef. proiect	arh. Emil Crișan	<i>[Signature]</i>	scara:	titlul plansei: BISERICA nr. pl.
proiectat	ing. Bodor Csaba	<i>[Signature]</i>	1: 150	PLAN LA COTA: +15.80, +20.80, +24.90 R - 104
desenat	Balázs Márta	<i>[Signature]</i>		
data elaborarii proiectului:		2018		

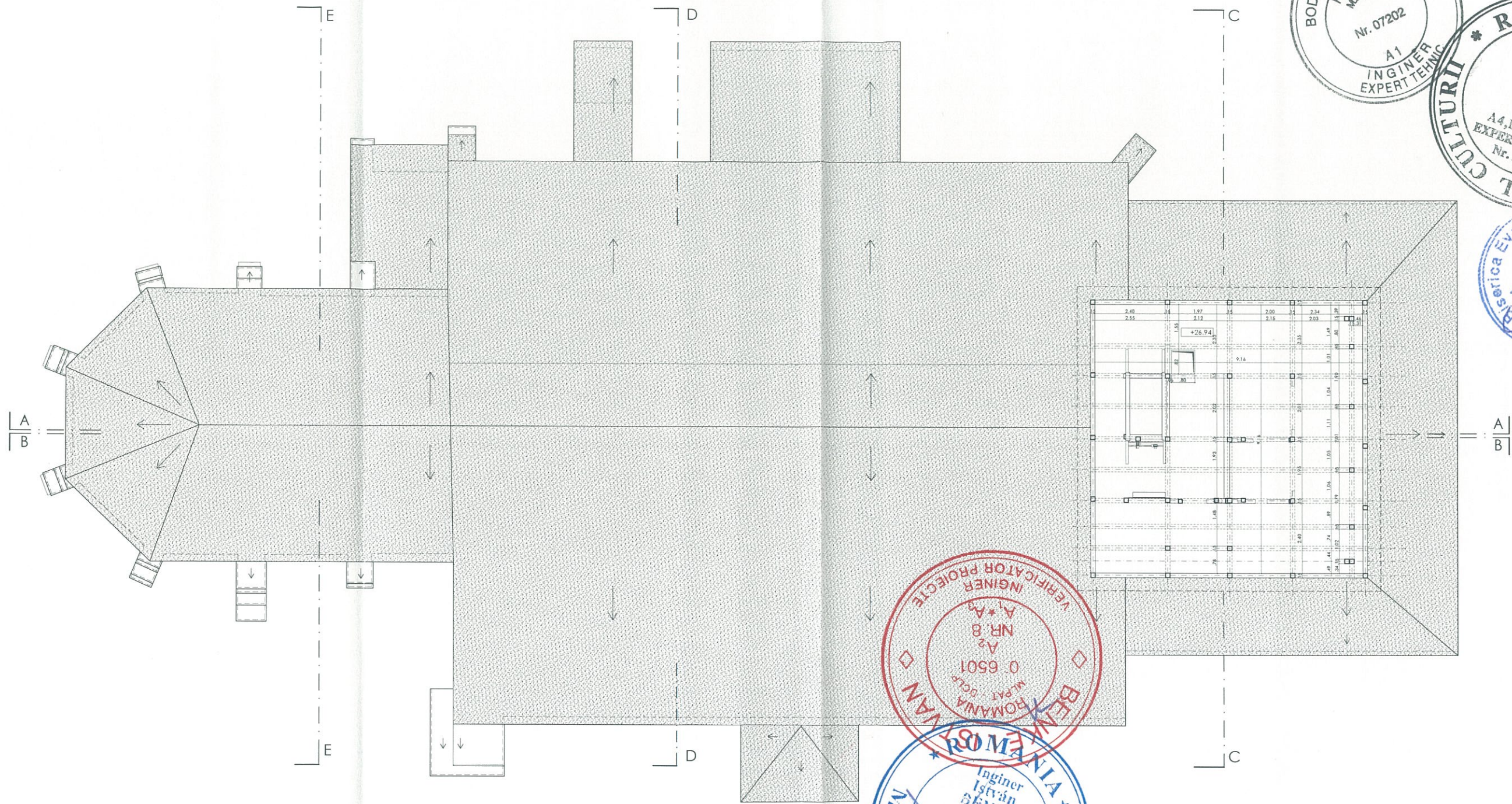

Proiectant General: E.M.A. EMIL A. CRIȘAN

verificator	expert	ing. Bodor Csaba	A1	24 / 07. 10. 2016
verificator / expert	nume	semnatura	cerinta	referat / expertiza nr. / data

<b>LINEA S.R.L. SF. GHEORGHE</b> str. Gróf Mikó Imre nr. 4, bl. 1/ E / 24 Reg. Com. J 14 / 122 / 1999 C.U.I. RO 11942771 tel./fax 0267-315714, web: www.linea-proiect.ro		Denumirea: REABILITAREA ANSAMBLULUI BISERICII EVANGHELICE FORTIFICATE AGNITA Localitatea: AGNITA, Piata G.D. Teutsch, nr. 1-3, jud. SIBIU Beneficiar: Parohia Evanghelică C.A. Agnita	proiect. nr. 180 / 2018 faza: P. T. + D. E.
---	--	---	--

sef. proiect	arh. Emil Crișan		scara: 1: 150	titlul plansei: BISERICA PLAN LA COTA: +28.50	nr. pl. R - 105
proiectat	ing. Bodor Csaba				
desenat	Balázs Márta				
data elaborarii proiectului:		2018			

Acest proiect este proprietatea SC LINEA SRL și asupra sa funcționează legea copyrightului. El nu poate fi folosit în ansamblu sau în părți ale sale decât cu aprobarea scrisă a SC LINEA SRL. Orice modificare ulterioară a proiectului, făcând fără aprobarea scrisă a proiectantului, este absolut pe acesta de orice răspundere.

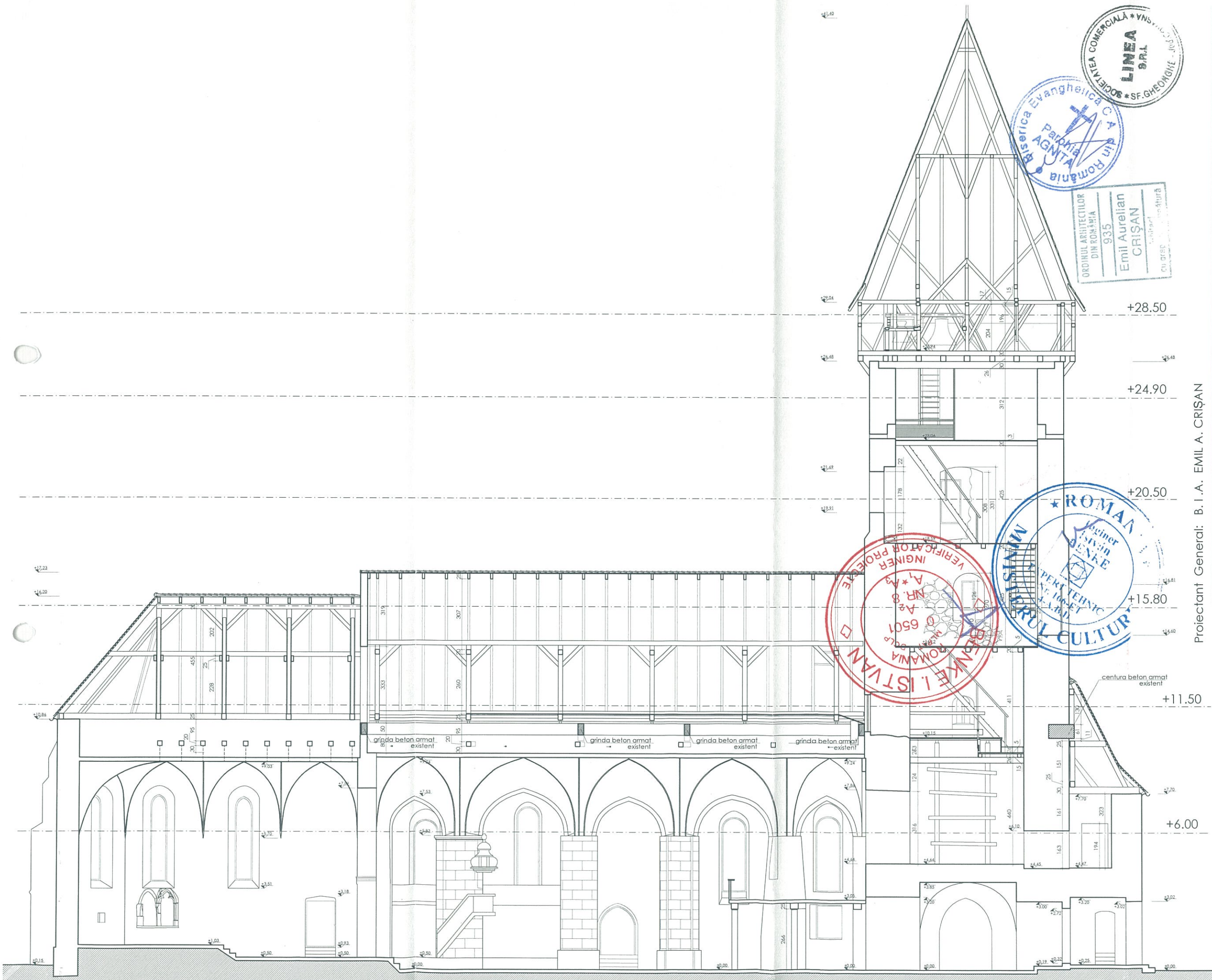

Proiectant General: B. I. A. EMIL A. CRIȘAN

verificator expert	ing. Bodor Csaba	A1	24 / 07. 10. 2016
verificator / expert	nume	semnatura	referat / experiza nr. / data
sef. proiect	ing. Bodor Csaba		
proiectat	ing. Bodor Csaba		
desenat	Balázs Márta		
data elaborării proiectului:	2018		
Denumirea:	REABILITAREA ANSAMBLULUI BISERICII EVANGHELICE FORTIFICATE AGNITA		
Localitatea:	AGNITA, Piata G.D. Teutsch, nr. 1-3, jud. SIBIU		
Beneficiar:	Parohia Evanghelică C.A. Agnita		
scara:	1: 150	titlul plansei:	BISERICA
nr. pl.	SECTIUNE LONGITUDINALA A - A		nr. pl. R - 106
proiect. nr.	180 / 2018		faza: P. T. + D. E.

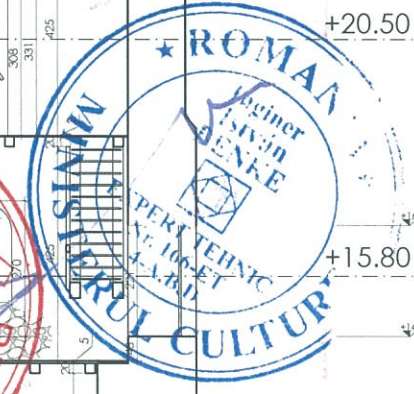
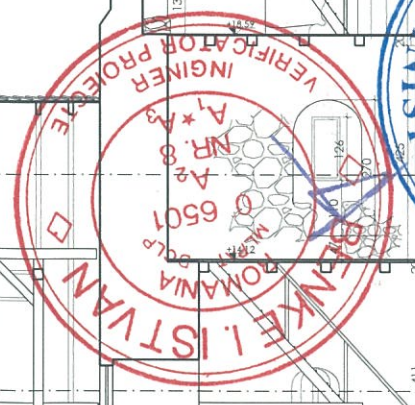
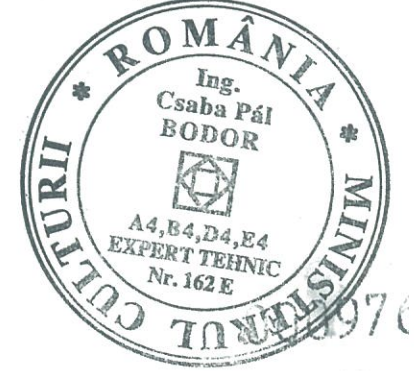

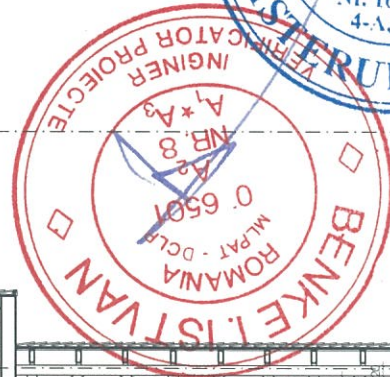
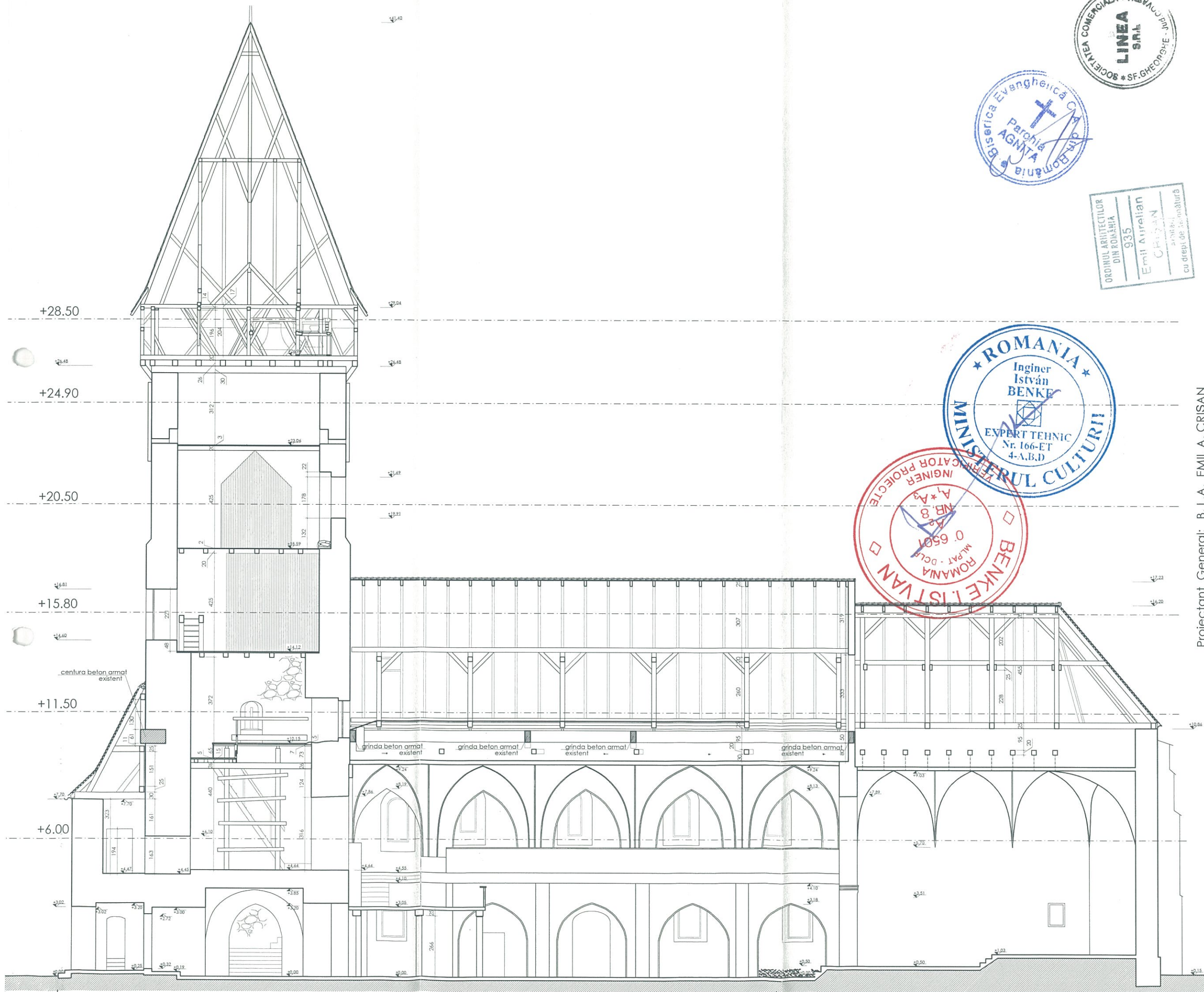

Proiectant General: B. I. A. EMIL A. CRIȘAN

verificator expert	ing. Bodor Csaba	AI	24 / 07. 10. 2016
verificator / expert	nume	semnatura	referat / experiza nr. / data
<b>LINEA S.R.L. SF. GHEORGHE</b> str. Gróf Mikó Imre nr. 4, bl. 1 / E / 24 Reg. Com. J 14 / 122 / 1999 C.U.I. RO 11942771 tel./fax 0267-315714, web: www.linea-proiect.ro		Denumirea: REABILITAREA ANSAMBLULUI BISERICII EVANGHELICE FORTIFICATE AGNITA Localitatea: AGNITA, Piata G.D. Teutsch, nr. 1-3, jud. SIBIU Beneficiar: Parohia Evanghelică C.A. Agnita	
sef. proiect	arh. Emil Crișan	scara:	titlul plansei:
proiectat	ing. Bodor Csaba	1: 150	BISERICA
desenat	Balázs Márta	SECTIUNE LONGITUDINALA B - B	
data elaborării proiectului:	2018	R - 107	
proiect. nr. 180 / 2018 faza: P. T. + D. E.			

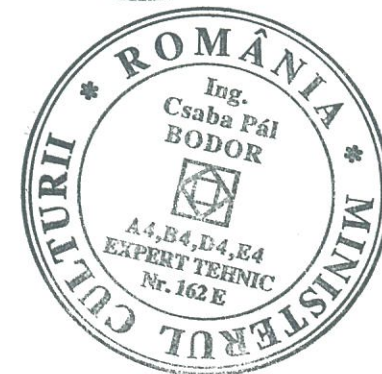

000977

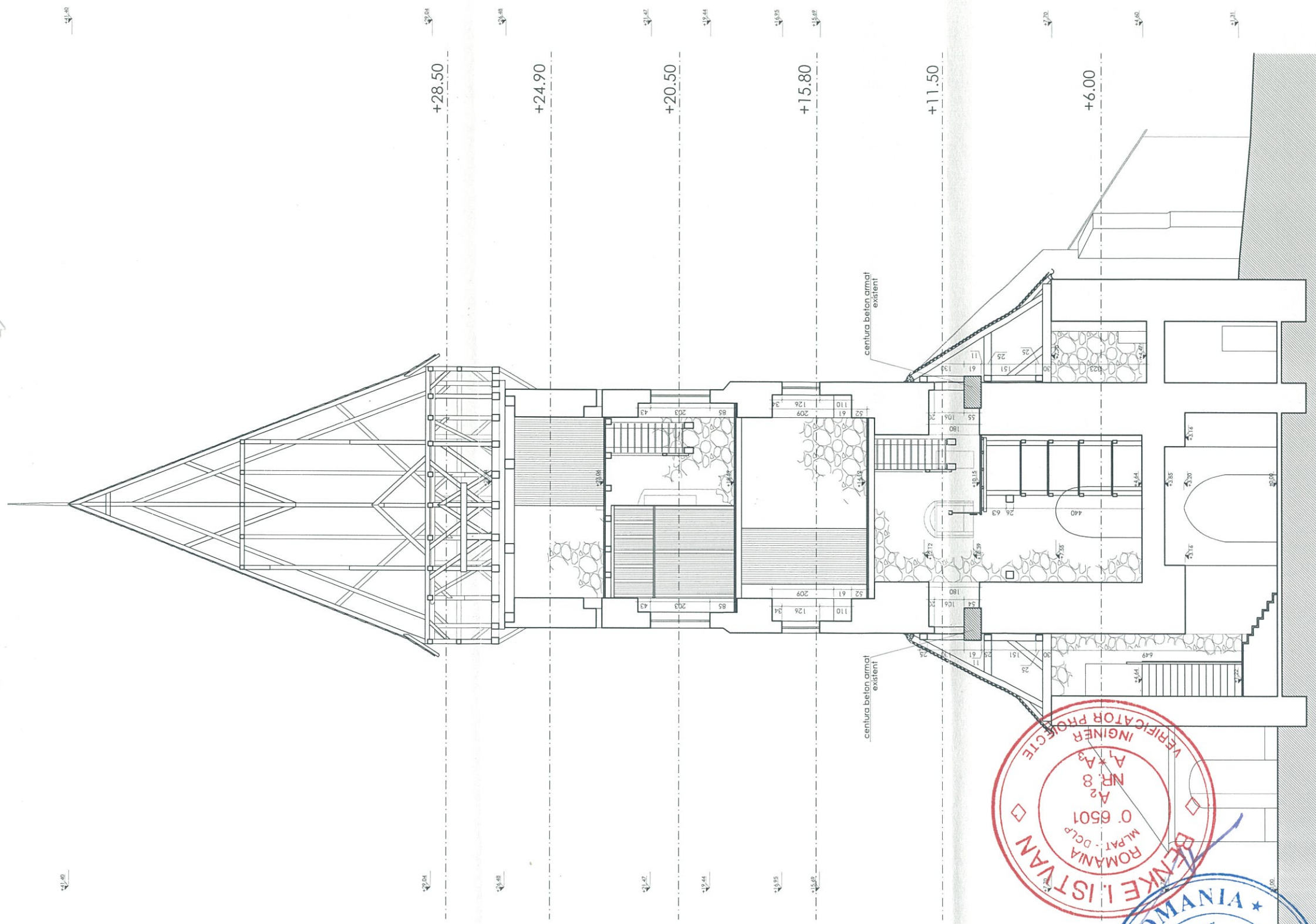

ROMANIA  
INGINER  
NR. 8  
A2  
A3  
A1  
VERIFICATOR PROIECTE

ROMANIA  
MLPAT - DCLP  
0.6501  
MLPAT - DCLP  
INGINER  
A1  
A2  
A3  
A4  
A5  
A6  
A7  
A8  
A9  
A10  
A11  
A12  
A13  
A14  
A15  
A16  
A17  
A18  
A19  
A20  
A21  
A22  
A23  
A24  
A25  
A26  
A27  
A28  
A29  
A30  
A31  
A32  
A33  
A34  
A35  
A36  
A37  
A38  
A39  
A40  
A41  
A42  
A43  
A44  
A45  
A46  
A47  
A48  
A49  
A50  
A51  
A52  
A53  
A54  
A55  
A56  
A57  
A58  
A59  
A60  
A61  
A62  
A63  
A64  
A65  
A66  
A67  
A68  
A69  
A70  
A71  
A72  
A73  
A74  
A75  
A76  
A77  
A78  
A79  
A80  
A81  
A82  
A83  
A84  
A85  
A86  
A87  
A88  
A89  
A90  
A91  
A92  
A93  
A94  
A95  
A96  
A97  
A98  
A99  
A100

ROMANIA  
INGINER  
NR. 8  
A2  
A3  
A1  
VERIFICATOR PROIECTE

ROMANIA  
MLPAT - DCLP  
0.6501  
MLPAT - DCLP  
INGINER  
A1  
A2  
A3  
A4  
A5  
A6  
A7  
A8  
A9  
A10  
A11  
A12  
A13  
A14  
A15  
A16  
A17  
A18  
A19  
A20  
A21  
A22  
A23  
A24  
A25  
A26  
A27  
A28  
A29  
A30  
A31  
A32  
A33  
A34  
A35  
A36  
A37  
A38  
A39  
A40  
A41  
A42  
A43  
A44  
A45  
A46  
A47  
A48  
A49  
A50  
A51  
A52  
A53  
A54  
A55  
A56  
A57  
A58  
A59  
A60  
A61  
A62  
A63  
A64  
A65  
A66  
A67  
A68  
A69  
A70  
A71  
A72  
A73  
A74  
A75  
A76  
A77  
A78  
A79  
A80  
A81  
A82  
A83  
A84  
A85  
A86  
A87  
A88  
A89  
A90  
A91  
A92  
A93  
A94  
A95  
A96  
A97  
A98  
A99  
A100

ORDINUL ARHITECTILOR  
DIN ROMANIA  
935  
Emil Aurelian  
CRIȘAN  
arhitect  
cu drept de semnătură

SOCIETEA COMERCIALĂ \*ANSAMBLU\* P.P. - J. GOVÂRNA \*LINEA S.R.L.\*  
S.F. GHEORGHE

Parohia  
AGNITA  
ROMANIA

Proiectant General: B. I. A. EMIL A. CRIȘAN

verificator expert	ing. Bodor Csaba	A1	24 / 07. 10. 2016
verificator / expert	nume	semnatura	referat / expertiza nr. / data
LINEA S.R.L. SF. GHEORGHE str. Gróf Mikó Imre nr. 4, bl. 1 / E / 24 Reg. Com. J.14 /122 /1999 C.U.I. RO 11942771 tel./fax 0267-315714, web: www.linea-proiect.ro	ing. Bodor Csaba	REABILITAREA ANSAMBLULUI BISERICII EVANGHELICE FORTIFICATE AGNITA	proiect. nr. 180 / 2018 faza: P. T. + D. E.
sef. proiectat	arh. Emil Crișan	titlul plansei:	BISERICA
proiectat	ing. Bodor Csaba	1: 150	SECTIUNE TRANSVERSALA C - C
desenat	Balázs Márta		
data elaborării proiectului:	2018		

ROMANIA  
INGINER  
NR. 8  
A2  
A3  
A1  
VERIFICATOR PROIECTE

ROMANIA  
MLPAT - DCLP  
0.6501  
MLPAT - DCLP  
INGINER  
A1  
A2  
A3  
A4  
A5  
A6  
A7  
A8  
A9  
A10  
A11  
A12  
A13  
A14  
A15  
A16  
A17  
A18  
A19  
A20  
A21  
A22  
A23  
A24  
A25  
A26  
A27  
A28  
A29  
A30  
A31  
A32  
A33  
A34  
A35  
A36  
A37  
A38  
A39  
A40  
A41  
A42  
A43  
A44  
A45  
A46  
A47  
A48  
A49  
A50  
A51  
A52  
A53  
A54  
A55  
A56  
A57  
A58  
A59  
A60  
A61  
A62  
A63  
A64  
A65  
A66  
A67  
A68  
A69  
A70  
A71  
A72  
A73  
A74  
A75  
A76  
A77  
A78  
A79  
A80  
A81  
A82  
A83  
A84  
A85  
A86  
A87  
A88  
A89  
A90  
A91  
A92  
A93  
A94  
A95  
A96  
A97  
A98  
A99  
A100

ROMANIA  
INGINER  
NR. 8  
A2  
A3  
A1  
VERIFICATOR PROIECTE

ROMANIA  
MLPAT - DCLP  
0.6501  
MLPAT - DCLP  
INGINER  
A1  
A2  
A3  
A4  
A5  
A6  
A7  
A8  
A9  
A10  
A11  
A12  
A13  
A14  
A15  
A16  
A17  
A18  
A19  
A20  
A21  
A22  
A23  
A24  
A25  
A26  
A27  
A28  
A29  
A30  
A31  
A32  
A33  
A34  
A35  
A36  
A37  
A38  
A39  
A40  
A41  
A42  
A43  
A44  
A45  
A46  
A47  
A48  
A49  
A50  
A51  
A52  
A53  
A54  
A55  
A56  
A57  
A58  
A59  
A60  
A61  
A62  
A63  
A64  
A65  
A66  
A67  
A68  
A69  
A70  
A71  
A72  
A73  
A74  
A75  
A76  
A77  
A78  
A79  
A80  
A81  
A82  
A83  
A84  
A85  
A86  
A87  
A88  
A89  
A90  
A91  
A92  
A93  
A94  
A95  
A96  
A97  
A98  
A99  
A100

000978



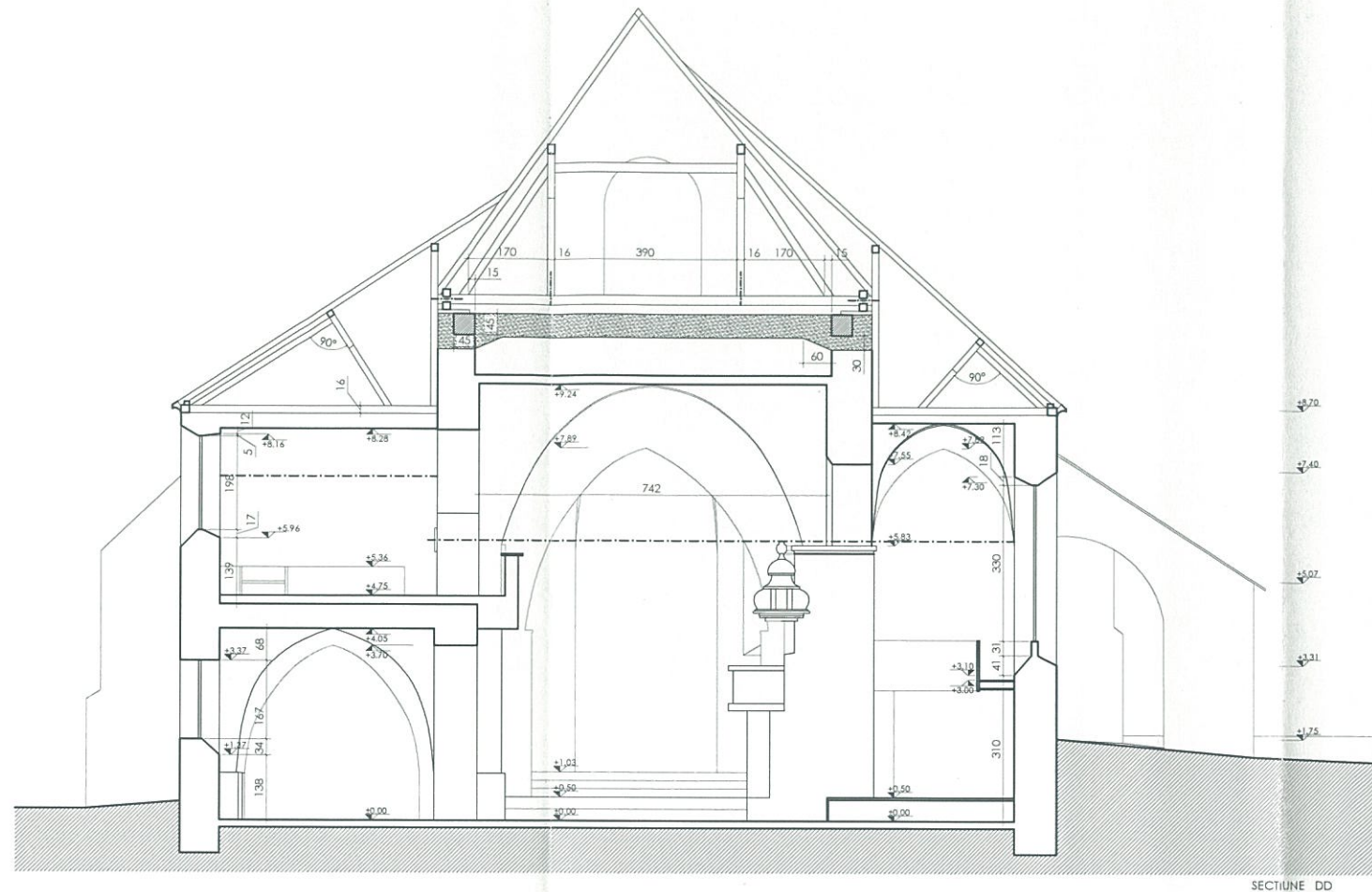

SECȚIUNE DD

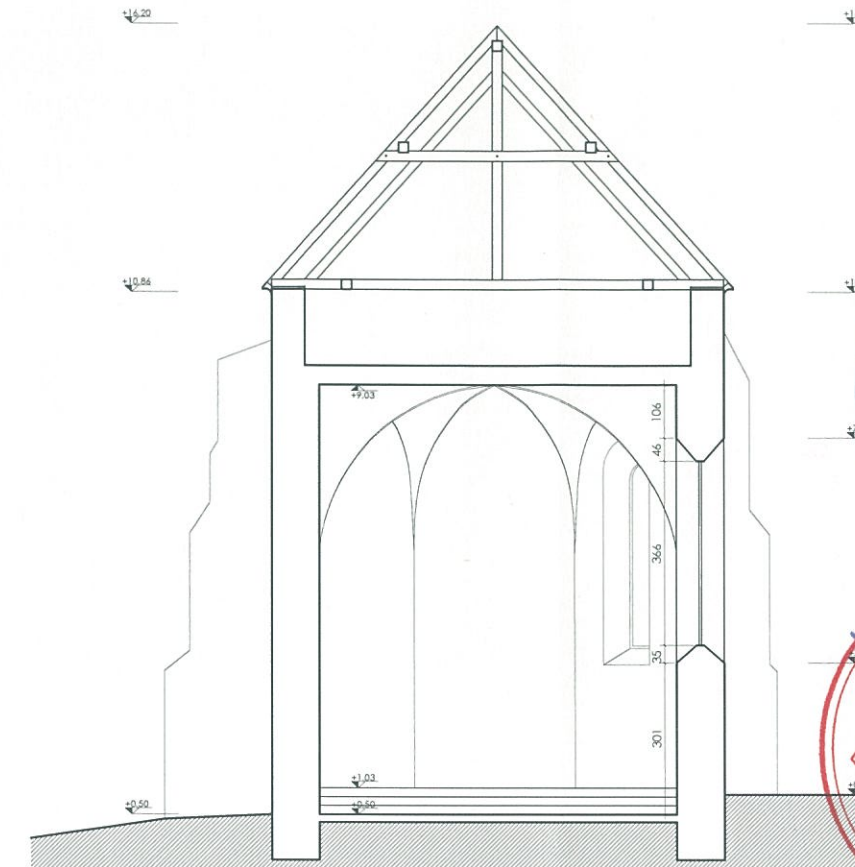

SECȚIUNE EE

LEGENDA:

----- - tiranți metalici existenți

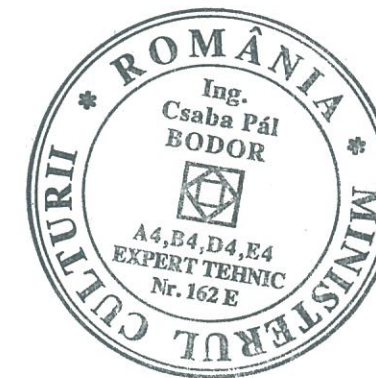

Proiectant General: B. I. A. EMIL A. CRIȘAN

verificator				
expert	ing. Bodor Csaba	<i>[Signature]</i>	A1	24 / 07. 10. 2016
verificator / expert	nume	semnatura	cerinta	referat / expertiza nr. / data

<b>LINEA S.R.L. SF. GHEORGHE</b> str. Gróf Mikó Imre nr. 4, bl. 1/ E / 24 Reg. Com. J 14 /122 /1999 C.U.I. RO 11942771 tel./fax 0267-315714, web: www.linea-proiect.ro		Denumirea:	REABILITAREA ANSAMBLULUI BISERICII EVANGHELICE FORTIFICATE AGNITA	proiect. nr.	180 / 2018
		Localitatea:	AGNITA, Piata G.D. Teutsch, nr. 1-3, jud. SIBIU	faza:	P. T. + D. E.
		Beneficiar:	Parohia Evanghelică C.A. Agnita		
sef. proiect	arh. Emil Crișan	scara:	titlul plansei:	BISERICA	nr. pl.
proiectat	ing. Bodor Csaba	1: 150	SECTIUNE TRANSVERSALA D - D, E - E		R - 109
desenat	Balázs Márta				
data elaborarii proiectului:		2018			

© Acest proiect este proprietatea SC LINEA SRL si asupra sa functioneaza toate drepturile de copyright. El nu poate fi folosit in niciun fel fara sa se dea seama de aprobarea scrisa a SC LINEA SRL. Orice modificare ulterioara a proiectului, fara aprobarea scrisa a proiectantului, este considerata pe propria raspundere.

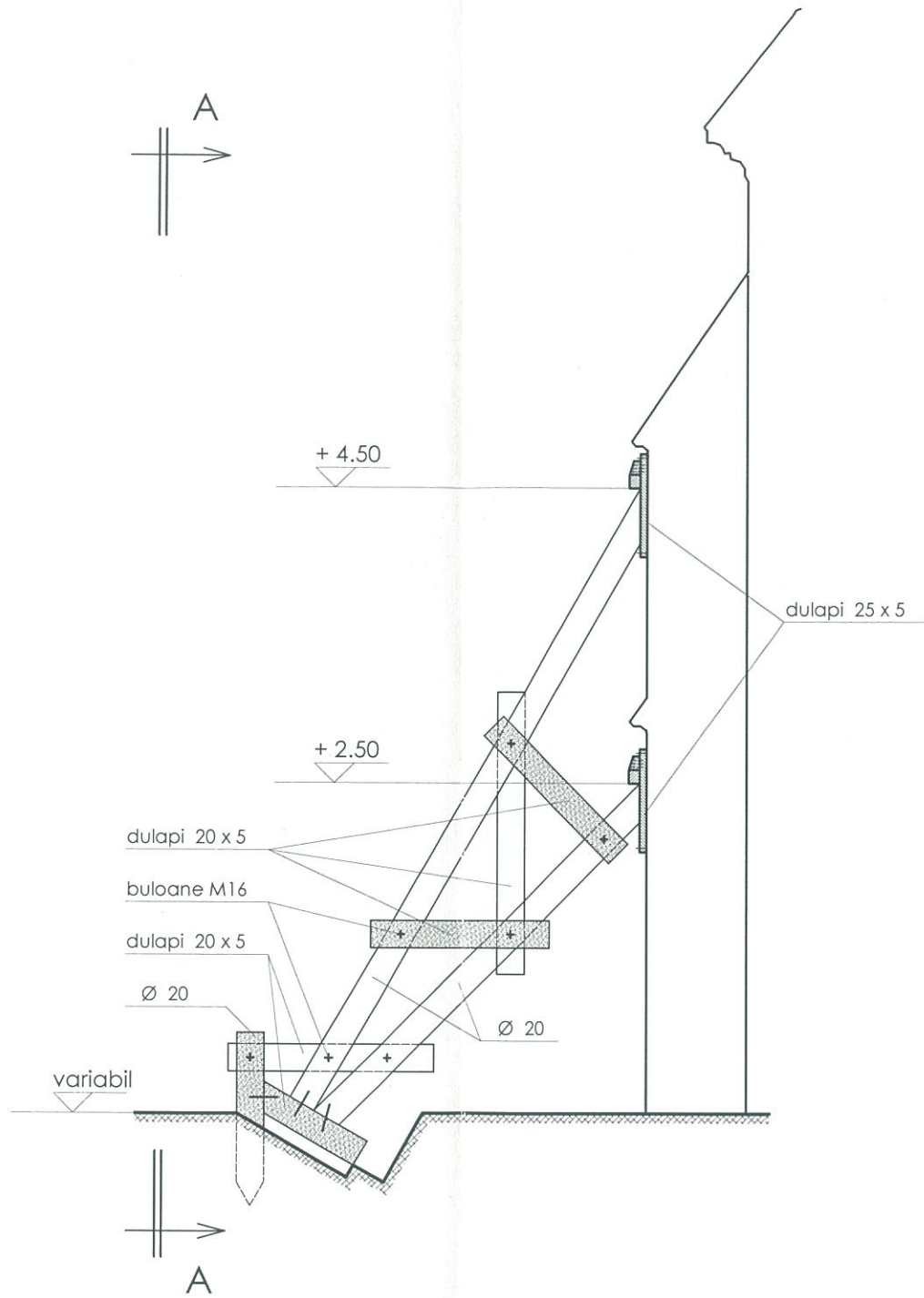

SPRIJINIRE CONTRAFORT

VEDERE A - A

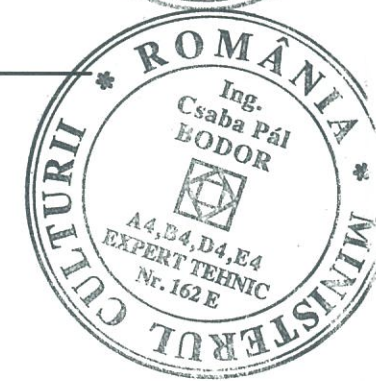
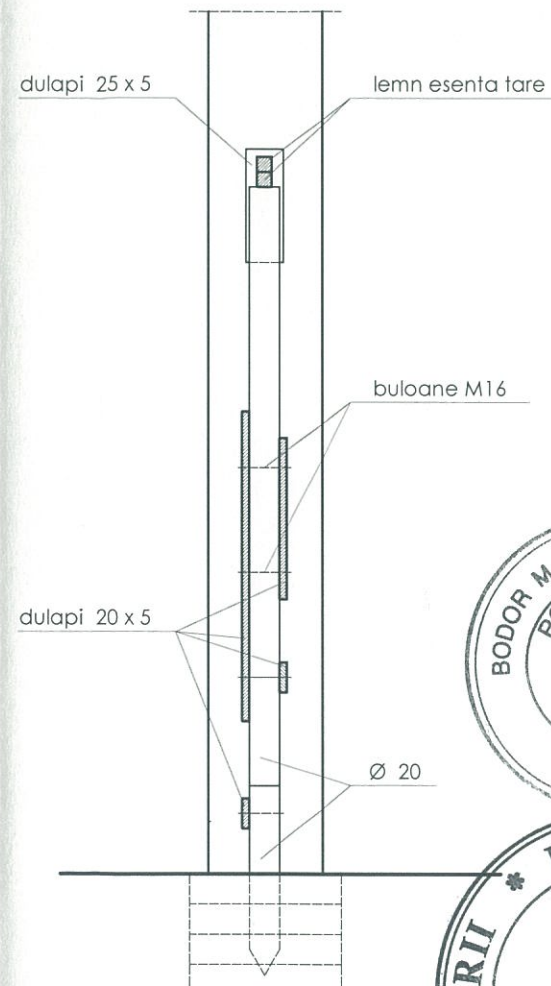

Proiectant General: B. I. A. EMIL A. CRIȘAN

verificator expert	ing. Bodor Csaba		A1	24 / 07. 10. 2018
verificator / expert	nume	semnatura	cerinta	referat / expertiza nr. / data

<b>LINEA S.R.L. SF. GHEORGHE</b> str. Gróf Mikó Imre nr. 4, bl. 1/ E / 24 Reg. Com. J 14 / 122 / 1999 C.U.I. RO 11942771 tel./fax 0267-315714, web: www.linea-proiect.ro		Denumirea:	REABILITAREA ANSAMBLULUI BISERICII EVANGHELICE FORTIFICATE AGNITA	proiect. nr.	180 / 2018
		Localitatea:	AGNITA, Piata G.D. Teutsch, nr. 1-3, jud. SIBIU	faza:	P. T. + D. E.
		Beneficiar:	Parohia Evanghelică C.A. Agnita		
sef. proiect proiectat	arh. Emil Crișan ing. Bodor Csaba		scara:	titlul plansei:	nr. pl.
desenat	Balázs Márta		1: 50	DETALII SPRIJINIRI CONTRAFORTURI	R - 110
data elaborarii proiectului:		2018			

Acest proiect este proprietatea SC LINEA SRL si asupra sa functioneaza legea copyrightului. El nu poate fi folosit in ansamblu sau in parti de sale decat cu aprobarea scrisa a SC LINEA SRL. Orice modificare ulterioara a proiectului, facuta fara aprobarea scrisa a proiectantului, este realizata pe seama de arhitectul proiectant.

### Plan subzidire contrafort

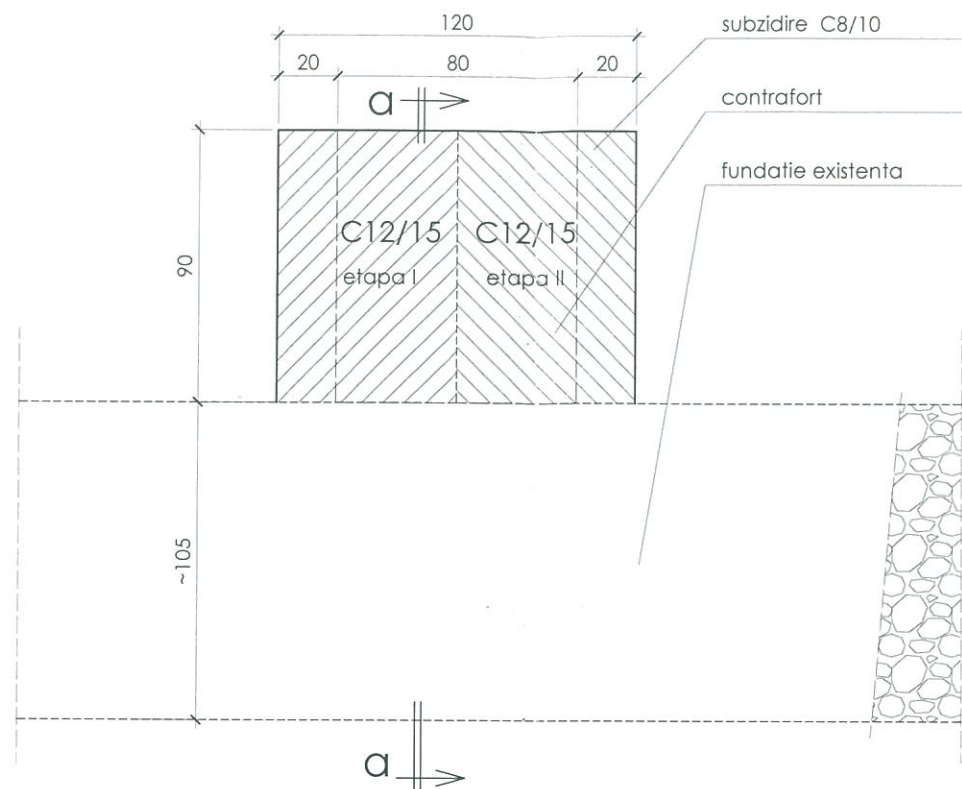

### Sectione a - a

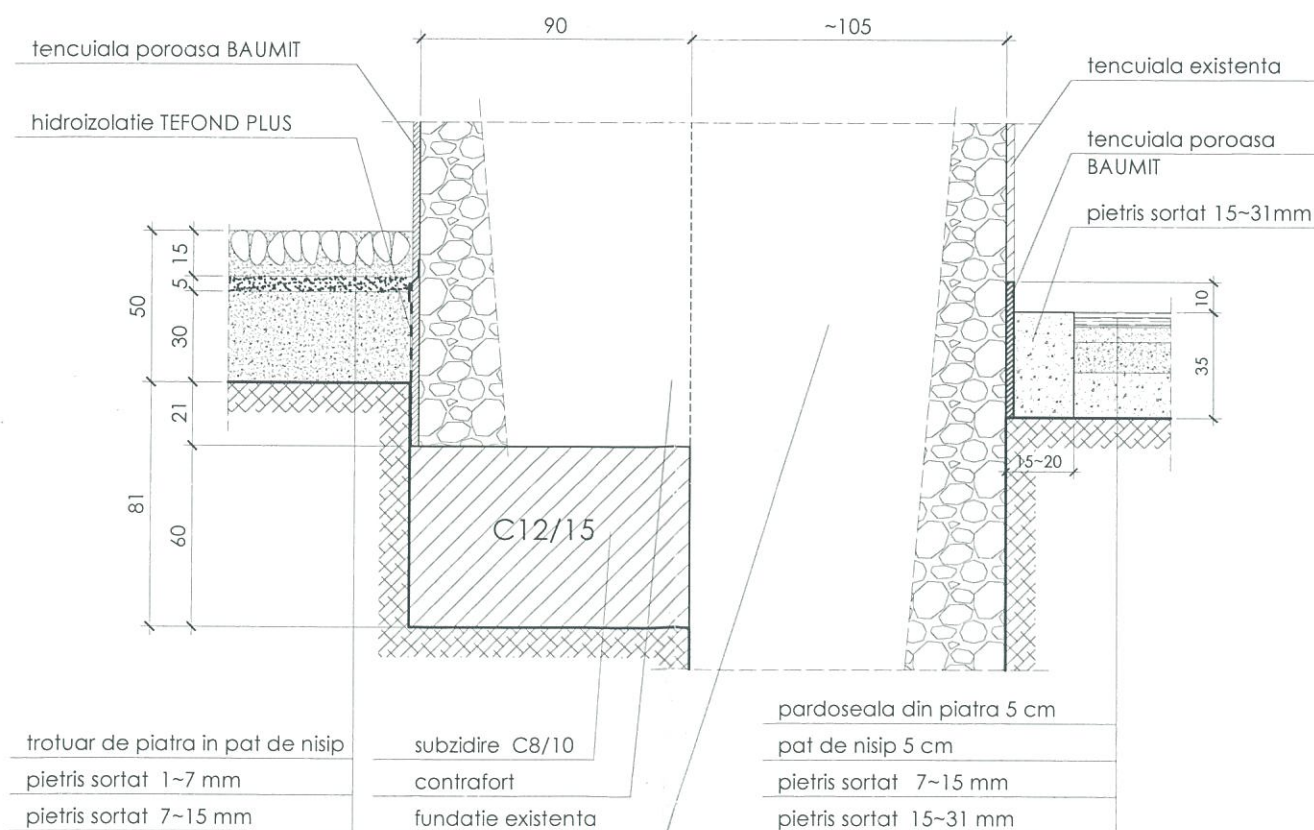

### Detaliu hidroizolatie fundatii

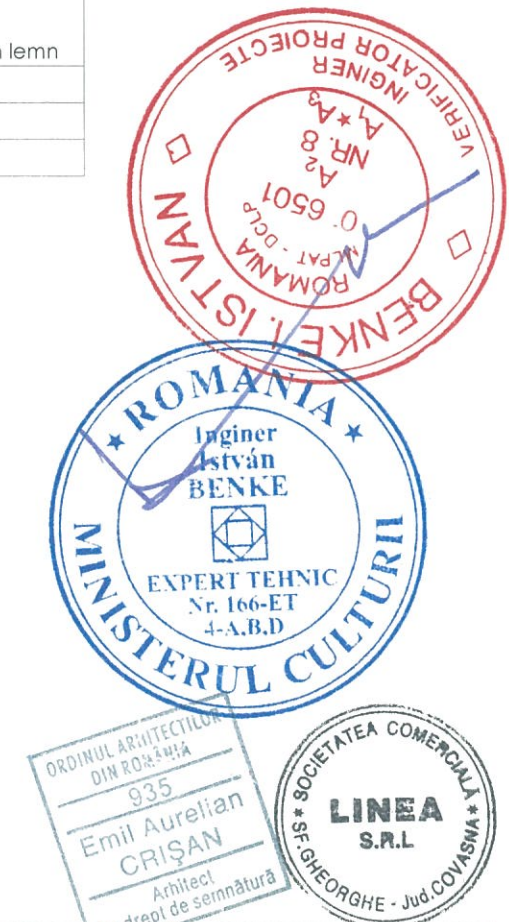
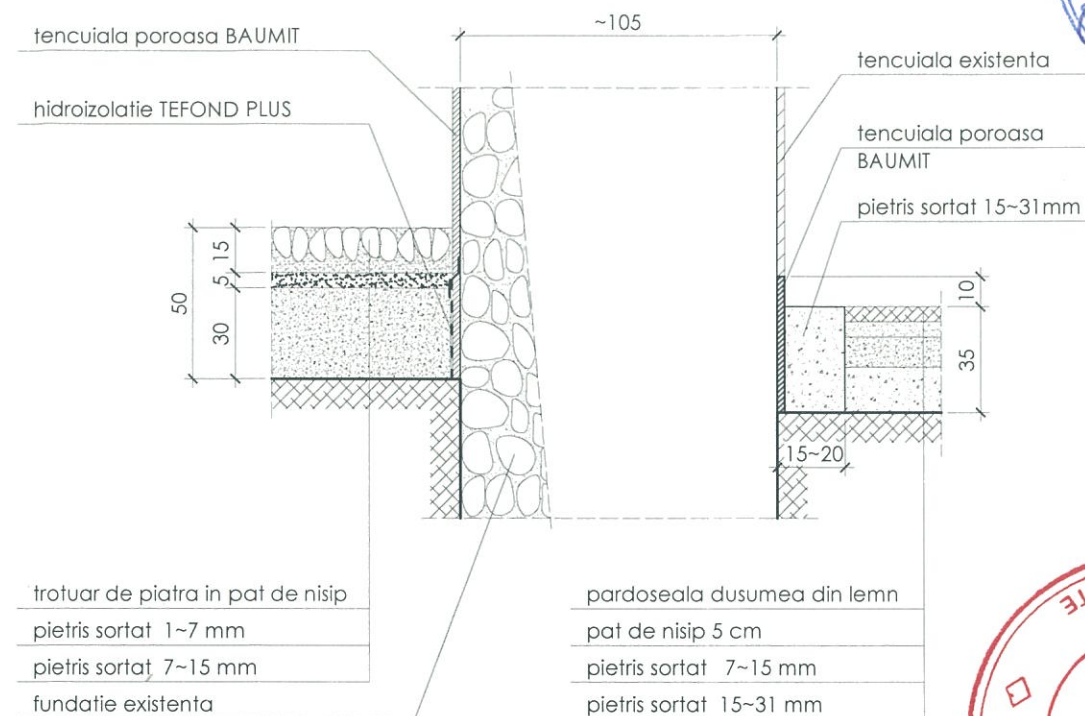

Proiectant General: B. I. A. EMIL A. CRIȘAN

verificator	ing. Bodor Csaba	<i>[Signature]</i>	A1	24 / 07. 10. 2016
expert				
verificator / expert	nume	semnatura	cerinta	referat / expertiza nr. / data

<b>LINEA S.R.L. SF. GHEORGHE</b> str. Gróf Mikó Imre nr. 4, bl. 1/ E / 24 Reg. Com. J 14 / 122 / 1999 C.U.I. RO 11942771 tel./fax 0267-315714, web: www.linea-proiect.ro		Denumirea: REABILITAREA ANSAMBLULUI BISERICII EVANGHELICE FORTIFICATE AGNITA Localitatea: AGNITA, Piata G.D. Teutsch, nr. 1-3, jud. SIBIU Beneficiar: Parohia Evanghelică C.A. Agnita	proiect. nr. 180 / 2018 faza: P. T. + D. E.
---	--	---	--

sef. proiect	arh. Emil Crișan	<i>[Signature]</i>	scara:	titlul plansei: BISERICA	nr. pl. R - 111
proiectat	ing. Bodor Csaba		1: 25	PLAN SUBZIDIRE CONTRAFORT, HIDROIZOLATIE FUNDATII	
desenat	Balázs Márta				
data elaborarii proiectului:	2018				